

VOLVO WHEEL LOADERS

L150F, L180F, L220F



MORE CARE. BUILT IN.



LOOKING FOR A LIFETIME PARTNERSHIP?

Volvo has refined the wheel loader concept for more than half a century. With the F-series' robust and reliable production loaders Volvo L150F, L180F, and L220F has taken another big leap ahead when it comes to safety, power, and operator comfort. They are built for highest machine and operator performance during those really long shifts in all types of jobs in rock loading, log handling, and material handling.

Volvo makes work easier

It's easier to do a good job in a Volvo wheel loader. The new Care Cab is the safest, most comfortable, and cleanest workplace we've ever built. From here, the operator has precision-control of the attachments with the patented TP-linkage and load-sensing hydraulics. Volvo's V-ACT environment-friendly engines and fully automatic transmissions give fast response and high maneuverability, even in tough operations and rough environments. For the Volvo L150F, L180F, and L220F, Volvo has developed a wide range of genuine Volvo attachments, perfectly matched to be an integrated part of the machine.

Owning a Volvo means peace of mind

With Volvo as your partner, you not only get a tough production machine, you also get outstanding world-class total economy. Our wheel loaders are renowned for their low fuel consumption, fast and easy maintenance, and high resale value. Volvo's global dealer and service network is there to support you. We're at your service with knowledge, genuine parts, and well-trained service personnel..



Specification	L150F	L180F	L220F
Engine:	Volvo D12D LD E3	Volvo D12D LA E3	Volvo D12D LB E3
Max power at	23,3-28,3 r/s (1400-1700 r/min)	23,3-26,7 r/s (1400-1600 r/min)	26,3 r/s (1600 r/min)
SAE J1995 gross:	210 kW (286 metric hp)	235 kW (320 metric hp)	261 kW (355 metric hp)
ISO 9249, SAE J1349 net:	209 kW (284 metric hp)	234 kW (318 metric hp)	259 kW (352 metric hp)
Breakout force:	184,7 kN*	214,7 kN**	224,5 kN***
Static tipping load at full turn:	15 280 kg*	18 260 kg**	20 750 kg***
Buckets:	3,1-12,0 m ³	3,7-14,0 m ³	4,5-14,0 m ³
Log grapple:	1,6-3,1 m ²	1,6-3,5 m ²	1,7-4,0 m ²
Operating weight:	23,0-26,0 t	26,0-30,0 t	31,0-35,0 t
Tires:	26.5 R25 775/65 R29	26.5 R25 775/65 R29	29.5 R25 875/65 R29

* Bucket: 4,0 m³ straight edge with bolt-on edges, tires: 26.5 R25 L3, standard boom.

** Bucket: 4,6 m³ straight edge with bolt-on edges, tires: 26.5 R25 L3, standard boom.

*** Bucket: 5,4 m³ straight edge with bolt-on edges, tires: 29.5 R25 L4, standard boom.



MOVE MATERIAL AT A LOWER COST

With Volvo L150F, L180F and L220F, rehandling is easy. Perfect-matched Volvo drivetrains, hydraulics and attachments offer an optimal combination of performance, fuel economy and environmental care. With all vital components well protected, the TP-linkage, rugged frames and all-cast mountings, Volvo brings you durable and reliable loaders that help you move material at a lower cost, even in the toughest operating environments.

Power and agility for fast work cycles

All Volvo wheel loaders have the latest HTE transmission with smooth shifting Volvo Automatic Power Shift (APS). They are both highly maneuverable and effective production machines, providing fast cycles in stockpile loading and enough power to handle really tough jobs in loading hard bank material. The high-performance engines have excellent response, and bucket movements are smooth and comfortable.

Smooth and powerful gravel, rock and log handlers

Volvo L150F, L180F and L220F have the power and maneuverable needed to take on and quickly handle demanding applications in log handling, hard bank and rock. All genuine Volvo attachments

are purpose-built and offer the same high quality as the rest of the machine. The machine and attachment work in perfect harmony with one another, forming a dependable cohesive unit that gets the job done both safely and efficiently.

Rugged rock loaders

Volvo L150F, L180F and L220 are uncompromising production machines for the heaviest jobs in the very toughest conditions. Availability is crucial, and therefore these machines are designed down to smallest detail to work without downtime, no matter how hard you push it.





SMOOTH SHIFTING AND HARMONIZING LOW-REV POWER. EXACT FORCE WITH LOWER FUEL CONSUMPTION

The environment-friendly engine's high torque near idle rpm gives the Volvo outstanding rimpull, low fuel consumption, and minimal emissions. The power and the fast response are results of perfect harmony between the in-house manufactured drivetrain, the load-sensing hydraulics, and the patented lift arm system. They make up a finely tuned unit, helping the operator to get more done with lower fuel consumption, by only using the needed power for every segment of the job.

Efficient and reliable low-emission technology

The 12-liter engine with Volvo Advanced Combustion Technology (V-ACT) makes Volvo L150F, L180F, and L220F both powerful and easy to operate. The V-ACT engine uses every drop of fuel, providing full power already at low rpm while meeting all tough standards for reduced emissions.

Smother automatic shifting

Volvo Automatic Power Shift (APS) contributes to fast and effective work cycles. The system is dependent on ground speed and engine rpm. All the operator has to do is select forward or reverse. The automatic shifting adapts to the operating conditions and saves fuel by always selecting the right



gear. The transmission features automatic downshift to 1st gear when there's a need for extra power.

Volvo's axles keeps the machine on the ground

Volvo's in-house manufactured axles and drivetrain are tailored to each other and dimensioned for high operating reliability. The front axle is equipped with a hydraulically operated differential lock with 100 percent locking. The rear axle is mounted in a maintenance-free axle cradle, which means that the operator doesn't have to carry out lubrication and there is no downtime.

Smooth and effective braking

Volvo L150F, L180F, and L220F feature Volvo's hydraulically operated, circulation-cooled, wet disc brakes. They have long operating life and provide smooth, effective braking action.

SmartShift takes productivity, comfort and fuel efficiency to the next level

Volvo SmartShift* includes not only a new torque converter with lock up, but a Volvo patented Reverse by Braking (RBB) function as well. Thus it provides higher productivity, reduced fuel consumption and increased operator comfort in Load and Carry applications and short cycle loading.

Fuel-efficient Volvo V-ACT D12-engines

Turbocharged low-emission, high-performance engine with air-air intercooler

Electronic engine control with overspeed protection for optimal performance in all operating situations

Hydrostatically driven, electronically controlled cooling fan works only when needed, which saves fuel

Smooth shifting electro-hydraulic HTE-transmission

Fuel-saving Automatic Power Shift (APS) selects the right gear for the job and current operating conditions

Smooth shifts and high comfort with Pulse Width Modulation (PWM) gear selector valve

Four gears forward, four reverse

The transmission automatically downshifts to first gear when needed

Rugged in-house developed axles

Volvo's axles are an integrated part of the drivetrain – an effective power pack

100 percent lockable differential lock on the front axle for best traction in difficult conditions

Lubricated-for-life rear axle bearings promote higher uptime and longer service life

Wet disc brakes for greater safety

All-hydraulic dual circuit system for greater safety

Contronic performs electronic brake test

Simple checking of brake pads with brake wear indicator on all wheels

*Optional equipment



IN PERFECT CONTROL ALL THE WAY

Volvo's unique TP-linkage maintains its high breakout torque throughout the entire lifting range. The operator has complete control, thanks to precision-steering and pilot-operated fingertip control of the load-sensing hydraulics. The short distance between the load's center of gravity and the front axle improves stability, resulting in greater safety, faster work cycles, and less spill in all types of applications.

Superior breakout torque throughout the entire lifting range

Volvo's unique, patented, and highly reliable lift arm system TP-linkage gives optimal breakout torque and outstanding parallel movement throughout the entire lifting range. The system is operator-friendly and gives the operator good control of heavy loads with plenty of power and complete control.

The right power, regardless of engine rpm

Volvo's wheel loaders feature an intelligent load-sensing hydraulic system, providing exact distribution of power when and where it's needed, regardless of engine rpm. The system makes the wheel loader easy to operate, saves fuel, and assists the operator in controlling both machine and load.



Easy precision steering

The precision steering is easily operated and exact even at low engine rpm. The hydrostatic, load-sensing steering system only works when you turn the steering wheel to save fuel. End-position stops for better comfort.

Faster, without spills

The long wheel base enables Volvo's wheel loaders to ride smoothly and comfortably on rough ground. The Boom Suspension System (BSS)* increases productivity by up to 20 percent, and is available as an option.

Heavy-duty engineered frames

Rugged frame design for secure mounting of components, reduces vibrations and increases the machine's operating life. Volvo's frame joint bearing design is a well-proven concept that's easy to maintain and renowned for its long service life.

TP-linkage combines power and precision

Volvo's patented lift arm system combines the best of parallel and Z-bar linkages

Load-sensing hydraulic system

Saves fuel by no unnecessary circulation of hydraulic oil

Operator-friendly, pilot-operated fingertip control of the attachment

3rd* and 4th* hydraulic functions enable use of hydraulic attachments

Load-sensing steering

Saves fuel by only using power when you steer

Gives increased comfort and operating safety

Comfort Drive Control (CDC)*

Switch between steering with the steering wheel and CDC to avoid static muscle loads

Handle steering and shifting forward-reverse with controls in the left armrest

Frames

Rugged frame design with three-point suspension of engine and transmission reduces vibrations and sound level.

* Optional equipment



EXTREME ENDURANCE IS A MACHINE THAT JUST KEEPS ON GOING

With big loaders, availability is everything. If the machine stops, work stops. That's why Volvo L150F, L180F, and L220F are designed, down to the smallest detail, to work without downtime, no matter how hard you push it. For us it's only natural and obvious to protect all expensive and vital components to prevent costly downtime and repairs. A Volvo is built to run.

Volvo - a quality concept in itself

Before a new machine generation is launched on the market, every vital component and newly designed system has been individually durability and fatigue-tested in test rigs. Only after passing that stage are they ready to meet the world's toughest test environment - the customers' reality - for thousands of hours in our prototypes and pre-series machines. The test hosts provide their feedback and comments about every detail directly to Volvo's engineering department. Volvo's Reliability Growth test technology means more test hours, improved measuring precision, and predictability in quality assurance. Volvo is a quality concept in itself. We set our goals a little higher.

Get the most out of your Volvo

Your machine should be profitable, not only today but tomorrow as well. At Volvo we have an extensive range of different tools, programs, and service agreements ensuring that your Volvo will give you optimal usage and profitability for a long time ahead. Since different businesses have different needs, we've made it easy for you to select the right level of Customer Support - from a program of regular machine inspections to a comprehensive repair and maintenance program that removes the need for an on-site workshop.

High resale value and long service life

Volvo L150F, L180F, and L220F are not just some of the most productive loaders on the market - they are also three of the most cost-effective. There are several reasons for this - Volvo's renowned reliability, our excellent financing packages, the low fuel consumption, the high resale value, and the minimal service requirement. All this makes it the most productive and reliable machine in the business. Shift after shift, year after year.



L150F, L180F, and L220F are equipped with Volvo high-quality hydraulic hoses, to be able to handle extreme stresses and high temperatures.

Volvo's wheel loaders feature rugged heavy-duty axles

Lubricated-for-life rear axle cradle, which reduces wear and maintenance costs

Since wheel loaders operate in dusty environments, Volvo has a system with replaceable breather filters that shut out dirty air from transmission, axles, fuel tank, and hydraulic tank

High-quality components that can handle tough conditions

Volvo Reliability Growth (RG) tests for high quality during thousands of hours

Volvo's frame joint with ingenious bearing design, renowned for its long service life

All electric cabling is well protected from water, dirt, and wear in solidly fastened, heavy-duty conduits with rubberized connectors and terminal caps



PROTECTION TO STAY FOCUSED IN OPERATION

Volvo has designed wheel loaders since 1954. Right from the beginning we put safety first, and we have used all the experience and knowledge we have amassed throughout these years to make the L150F, L180F, and L220F as safe as possible. But not at the expense of comfort, operating joy, and power. Quite the opposite. We know that safety as well as productivity partly is the result of a satisfied operator – man and machine in perfect harmony.

Generous space

You really feel welcome in Volvo's latest cab. It's both wider and deeper than its predecessor. There is lots of space to stretch out your legs, and ample space for storage boxes, boots, and cups. The large, swept windshield gives excellent visibility in every direction, up high as well, making it easy to load even with Long Boom. To facilitate communication with others on the site, there is a sliding window on right side. All instruments are easy to read, and on the right side all buttons are very easily accessible on a sturdy aluminum pillar. Several seats and adjustment features make it easy to find a comfortable operating position. With lever steering

(Comfort Drive Control, CDC)*, the operator can handle steering and shifting forward/reverse with controls in the left armrest to avoid static muscle loads.

Always a comfortable climate

Volvo's unique and patented two-stage cleaning re-circulates up to 90 percent of the air, and only 10 percent comes from the outside. The air in the cab is cleaned to 98 percent. Automatic Heat Control (AHC) is standard and ensures a comfortable temperature in the cab. And if the operator needs a break, the heat* can be left on even with the engine off, which both saves fuel and protects the environment.



Care Cab - a more effective workplace

Comfortable cab climate with the market's best filter system

Adjustable steering wheel, seat, armrest *, and lever carrier

Viscous damping of cab mounting reduces vibrations

Improved visibility all around the machine increases safety on the work site

Easy access buttons and controls

Easy-to-clean interior

Several storage compartments

Laminated front windshield protects the operator

Practical sliding window on right side

Service platforms and steps with slip protection as well as well-placed handrails for optimal safety

Powerful halogen work lights front and rear give good visibility of the whole operating area

* Optional equipment



REAL-TIME INTELLIGENCE SUPPORTS MORE UPTIME

Contronic helps you add more productive time to your working day by minimizing the need for unplanned service. The system monitors the wheel loader's functions in real-time and provides access to valuable operating data and service information. The operator can check fluid levels and service needs from the cab, service technicians can find the problem faster, and the owner can easily optimize the wheel loader to new operating conditions, or remote-monitor the machine with the new optional equipment CareTrack.

Contronic in complete control

Service-friendliness is important to your productivity. The more you are going to use the wheel loader, the more important it is to be able to perform daily service fast and easy. That's why all filters and service points are easily accessed on a Volvo, and all hatches are large and easy to open. Volvo Contronic handles some of the daily checks by fast and easy electronic level checks of oils and fluids. Contronic is an integrated network that continuously monitors the wheel loader's operation and performance in real-time. The system works at four levels.

Level 1: The system keeps an eye on the machine's functions in real-time. If something abnormal should occur, Contronic automatically generates an immediate warning and brings the situation to the operator's attention. A service technician can log in to the system and troubleshoot the problem directly on-site.

Level 2: All operating data about how the machine is operated and what has happened since the last service is stored in Contronic. The information is presented in the MATRIS analysis program, giving valuable information for troubleshooting and service actions.

Level 3: The wheel loader's functions and performance can be updated and adapted to changing operating conditions via Contronic with VCADS Pro analysis and programming tool.

Level 4: The new optional equipment CareTrack* enables remote monitoring of the wheel loader's geographical position, fuel economy, and function for optimal support. With CareTrack Advanced, it's also possible to detect unauthorized use, analyze error codes, and solve problems over long distances. Operating data needed to increase the wheel loader's productivity is gathered on a password-protected website for analysis.

Contronic increases operating reliability

Contronic monitoring system generates warnings and shows diagnostics for actions

Display shows continuous operating data, warning texts, and error messages

Available in 24 languages

Monitors fuel consumption, cycle times, and service intervals

Electronic checks of oil and fluid levels from the cab

Built-in safety functions automatically limit engine torque and power in case of major malfunctions in order to reduce the risk of subsequent damage

Maintenance and availability

Easily accessible hatches and service points make service easier

Pressure check connections and quick-couplings are conveniently grouped for fast and simple inspections

Long lubrication intervals mean more time for productive work

Well-designed steps, handrails, and handles for safe and comfortable service

Breather filters protect the transmission, axles, fuel tank, and hydraulic oil tank

Volvo's oil-bath pre-cleaner*, in combination with the standard air filter, gives significantly higher effectiveness in extremely dusty operating conditions.

CareTrack* telematics

GPS positioning, mapping, Geo- & Time fence functions monitor your machine fleet

GPRS and/or Satellite transfer of operating data, error codes**, and logged machine data**

Service reminders and alarms, including forwarding by E-mail and text message

* Optional equipment

** Only available with CareTrack Advanced



GROWTH IN HARMONY WITH THE ENVIRONMENT

Volvo's core values are quality, safety, and environmental care. We regard our commitment to the environment as a natural part of our entire operation, the goal of which is to maximize productivity and efficiency at the lowest possible cost and minimal environmental impact. With a Volvo, you get one of the market's cleanest and most reliable wheel loaders.

Powerful, dependable, and environmentally optimized

With the new generation of turbocharged diesel engines, Volvo has taken yet another giant stride ahead to reduce emissions, without any dramatic changes that reduce engine power. This is possible thanks to the new V-ACT (Volvo Advanced Combustion Technology). The V-ACT system's secret is its advanced fuel injection and electronic engine control, making efficient use of every drop of fuel. The smart system for internal exhaust gas recirculation, I-EGR, reduces Nox-emissions by lowering peak combustion temperatures.

More than 95 percent recyclable

Volvo's core values are quality, safety, and environmental care. Today, our wheel loaders are almost completely recyclable. Components such as engine, transmission, and hydraulics are overhauled and re-used in our exchange system.

Volvo cares about the environment

Engine D12 meets all governing emission requirements according to step IIIA in Europe and Tier 3 in the USA

Volvo's wheel loaders are manufactured in environmentally certified plants according to ISO 14001

Load-sensing hydraulic and steering systems contribute to lower fuel consumption

More than 95 percent recyclable by weight

Low sound levels, inside and outside

Optional biodegradable hydraulic oil allows environment-friendly operation

Volvo means quality

Replaceable breather filters shut out dirty air from transmission, axles, fuel tank, and hydraulic tank

High-quality components that can handle tough conditions and environments

Volvo's frame joint with ingenious bearing design, renowned for its long service life

All electric cabling is well protected from water, dirt, and wear in solidly fastened, heavy-duty conduits with rubberized connectors and terminal caps

Volvo Reliability Growth (RG) tests for thousands of hours

Volvo means safety

Dual circuit service brake system meets all requirements for safe and effective brake function according to ISO 3450

Electronic brake test in Contronic

Simple checking with brake wear indicators increases safety

Automatic application of parking brake when the engine stops

Volvo Care Cab is tested and approved according to ROPS ISO 3471 and FOPS ISO 3449

Superb allround visibility gives effective control of the work site

Sloping engine hood gives better visibility to the rear

New design of steps and platforms, with slip protection and well-placed handrails



THREE MACHINES YOU CAN ALWAYS TRUST

Access and Serviceability

- Easily accessed hatches and service points
- Centralized, ground level lubrication banks and grouped pressure check connections
- Lubricated-for-life rear axle bearings
- Slip protected service platforms, handrails, wide and angled cab ladders provide safety
- Long lubrication intervals allow more time for productive work

Volvo Lift Arm System

- TP-Linkage – unique patented lift arm system
- Provides superior force throughout the lift cycle
- Optimized attachment visibility and great rollback angles
- Dual pin seals prevent contamination of pins

Commitment to Volvo's Core Values: Quality, Safety, and Care for the Environment

- Roll Over Protection System (ROPS) provides safe operation
- Non-return valves prevent leakage of both hydraulic and fuel tanks in case of roll-over
- High-quality breather filters on all major components
- Optional biodegradable hydraulic oil allows environment-friendly operation
- All Volvo wheel loaders are more than 95% recyclable
- All electrical wiring is routed through high-quality conduits with sealed connectors

World-Class, Volvo Care Cab

- Larger, more spacious cab interior with large storage compartments
- Care Cab features the market's best cab filtration system
- Front pillar-mounted switches
- Fully adjustable operator's seat, armrest*, lever carrier, and steering column
- Improved allround visibility includes wide, laminated front windshield and floor-to-ceiling glass
- Viscous damping helps to eliminate unwanted noise and vibrations



Volvo Load-Sensing Hydraulics

- Load-sensing hydraulic, load-sensing hydraulic system provides exact flow and pressure – when and where it's needed
- 3rd* and 4th* hydraulic functions for hydraulic attachments



Volvo Contronic Monitoring System

- Network monitors operation and performance in real-time
- The Contronic system warns the operator in time, making it easier for the service technician to troubleshoot, and helps the machine owner tailor the wheel loader to the application
- Fast and easy electronic level checks of oils and fluids
- Display shows continuous operating data, warning texts, and error messages
- Monitors fuel consumption, cycle times, and service intervals
- Available in 24 languages

Volvo Designed and Manufactured Engine

- Turbocharged Volvo V-ACT D12D, Tier 3/Stage IIIA-approved D12E provides tremendous power and impressive low-end torque
- Combines outstanding fuel economy, high reliability, and durability with low levels of noise and exhaust emissions
- Engine control with overspeed protection for optimal performance in all operating conditions
- Hydrostatically driven, electronically controlled fan works only when needed, which saves fuel

Volvo HTE Heavy-Duty Transmission

- Automatic Power Shift (APS) with automatic mode selector
- The transmission automatically downshifts to first gear when needed
- Smooth shifts and high comfort with Pulse Width Modulation (PWM) gear selector valve
- SmartShift* includes torque converter with Lock-Up and Reverse by Braking (RBB) for higher productivity, lower fuel consumption and increased comfort

Volvo AWB Heavy-Duty Axles

- Dual circuit service brakes and automatic parking brake application
- Outboard-mounted wet disc brakes and planetary hub reductions
- Differential lock with 100 % locking on the front axle
- Optional axle oil cooling provides maximized cooling capacity*
- Simple checking of brake discs with brake wear indicator on all wheels

Volvo Frames

- High-quality steel provides stress resistance and operational stability
- Low vibrations and incredibly quiet sound levels
- Well organized articulation joint provides very easy access for inspection and maintenance
- Upper and lower joints designed for the highest stress ensure long life and reliability

* Optional equipment

VOLVO GENUINE ATTACHMENTS – FOR A PERFECT MATCH

Volvo wheel loaders are renowned for their high quality and Volvo's genuine attachments offer exactly the same high quality. This is actually an absolute precondition for our machines to deliver what we promise – the highest possible productivity. Machines and attachments that are made for each other work best together.

The right tools for the job

Volvo's comprehensive range of attachments and smart options make it possible to tailor the wheel loader exactly right for the jobs and the operating conditions on your work site. Volvo's genuine attachment range includes buckets for all types of applications and materials, log grapples, material handling arms, and a variety of different fork attachments. The perfect connection between tool bracket and attachment is your guarantee for safety on the work site.

Perfect partners for every job

Every genuine Volvo attachment is designed as an integrated part of the wheel loader. Their functions and properties are exactly matched to parameters such as link

arm geometry and breakout, rimpull and lift force. Simply put, they are made for each other – perfect partners for every job.

Best penetration capability and long service life

Genuine Volvo attachments are durable and last up to three times as long as some other makes. This high quality stems partly from our long experience and partly from our close cooperation with some of the world's best material manufacturers. The high quality also applies to the bucket's wear parts. Their design and the materials from which they are made give Volvo's edge savers, teeth, and segments the best penetration capability, long service life, and short time for replacement of wear parts.

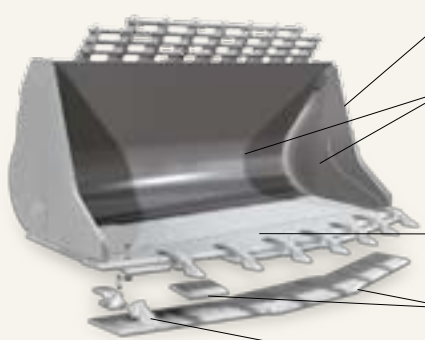

Bucket shell and side plates of up to 400 Brinell to withstand abrasive wear

Reinforced mounting points for attachment installation give less wear

Bucket cutting edges of abrasive-resistant steel of up to 500 Brinell

Replaceable bolt-on wear plates on bucket floor, 500 Brinell

Bolt-on edge savers and segments protect the cutting edge from unnecessary wear, 500 Brinell

Volvo's Tooth System with bolt-on or weld-on adapters of up to 515 Brinell gives excellent penetration and less bucket wear

Spade nose rock bucket with teeth and segments



Straight edge rock bucket with teeth and segments



General purpose bucket with teeth and segments



Rehandling bucket with bolt-on-edges



Light material bucket with bolt-on edges



Block handling fork



Log/Sorting grapples





BUILT TO RUN. SUPPORTED FOR LIFE

When you invest in a Volvo wheel loader, you get a construction machine of the very highest quality. But of course, even the best machines need service and maintenance to be as productive tomorrow as they are today. Customer Support will help you to keep an eye on your owning and operating costs.

We care about your operation - anywhere at anytime

Volvo Construction Equipment and Volvo Wheel Loaders center around a professional Customer Support organization, providing parts supply, after sales services and training. All this gives customer benefits through controlled owning and operating costs. When you invest in a Volvo wheel loader, the availability of good service and access to genuine Volvo parts are just as important as the price. After all, it is the total cost during the machine's entire life that's interesting. With all the products and resources we have at our disposal, we can offer you the best support. Anywhere, anytime.

Four levels of support, one level of care

The best way to get the most out of your Volvo wheel loader is to invest in a Volvo Customer Support Agreement. There are four levels of agreements designed to give you total peace of mind; white, blue, silver, and - of course - gold, which includes all service, maintenance and repairs during the whole contract period at a fixed price. From this completely flexible starting point, we can create an agreement uniquely tailored to the needs of your business and the age of your loaders.

Genuine Volvo parts leave nothing to chance

Each genuine Volvo part is developed to and manufactured together with all other machine components. It's a complete system where each part works in perfect harmony with other parts. Only by using genuine parts can you be sure that your machine retains the qualities and features we gave it from the beginning.



OPTIMIZE YOUR WHEEL LOADER



Selection of Volvo optional equipment

Boom Suspension System (BSS)

The Boom Suspension System absorbs shocks, eliminates rocking and bouncing, and smoothes out rough roads. BSS contributes to higher productivity, less spill, and better operator comfort

Long Boom

A long boom gives the extra dump height and reaches necessary for loading high trucks or feeders. The additional reach also gives added protection when loading the bucket by keeping the machine further away from the material.

Comfort Drive Control (CDC)

Lever steering CDC enables the operator to handle steering

and shifting forward-reverse with controls in the left armrest. At any time, the operator can change between steering with steering wheel and CDC to avoid static muscle loads.

Automatic Lubrication System

Our factory-installed Automatic Lubrication System takes care of greasing while the machine is in operation. This means less downtime for scheduled maintenance and more time for productive work.

Electro-hydraulic control

Pilot-operation with electric-servo hydraulics increases comfort with lighter lever forces and high

precision. Adjustable lift and bucket angles, Return-to-dig, and end-position damping are built-in functions. 3rd and 4th hydraulic functions enable use of hydraulically attachments

Rear-view camera system

Rear-view camera system reduces blind spots and increases site safety when reversing and also improves operator comfort.

CareTrack telematics system

Remote monitoring of the machine's position, utilization, and performance. Forwarding of error codes, alarms, and service reminders. Position on map plus Geo- & Time fence functions.

Mudguards

Front and swing-out rear mudguards – protect the machine in extreme environments.

Limited Slip

Volvo's Limited Slip differentials provide dependable traction in tough ground conditions, which reduces tire slip and simplifies operation.

Volvo SmartShift

In Load and Carry application the new Volvo SmartShift function gives you lower fuel consumption, higher productivity and increased comfort by adding a converter with Lock up. It also includes a Volvo patented Reverse by Braking (RBB) system which benefits comfort, durability and fuel consumption in short cycle loading.

VOLVO L150F, L180F, L220F IN DETAIL



Engine

Engine: V-ACT Stage III A/Tier 3, 12 liter, 6-cylinder in-line turbo-charged, air-to-air intercooler diesel engine with double rockers and Internal Exhaust Gas Recirculation (I-EGR). One-piece cylinder head with four valves per cylinder and one overhead camshaft. The engine has wet replaceable cylinder liners and replaceable valve guides and valve seats. Mechanically actuated electronically controlled unit injectors. The throttle application is transmitted electrically from the throttle pedal. **Air cleaning:** Three stage cyclone pre-cleaner - primary filter - secondary filter. **Cooling system:** Hydrostatic, electronically controlled fan and intercooler of the air-to-air type.

L150F

Engine	Volvo D12D LD E3
Max power at	23,3–28,3 r/s (1400–1700 r/min)
SAE J1995 gross	210 kW (286 metric hp)
ISO 9249, SAE J1349 net	209 kW (284 metric hp)
Max torque at	23,3 r/s (1400 r/min)
SAE J1995 gross	1432 Nm
ISO 9249, SAE J1349 net	1423 Nm
Economic working range	800–1600 r/min
Displacement	12,13 l

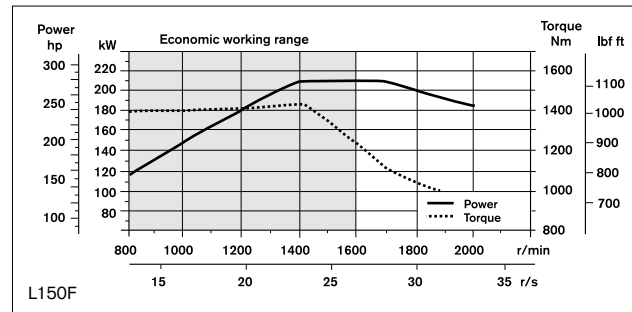

L180F

Engine	Volvo D12D LA E3
Max power at	23,3–26,7 r/s (1400–1600 r/min)
SAE J1995 gross	235 kW (320 metric hp)
ISO 9249, SAE J1349 net	234 kW (318 metric hp)
Max torque at	23,3 r/s (1400 r/min)
SAE J1995 gross	1603 Nm
ISO 9249, SAE J1349 net	1594 Nm
Economic working range	800–1600 r/min
Displacement	12,13 l

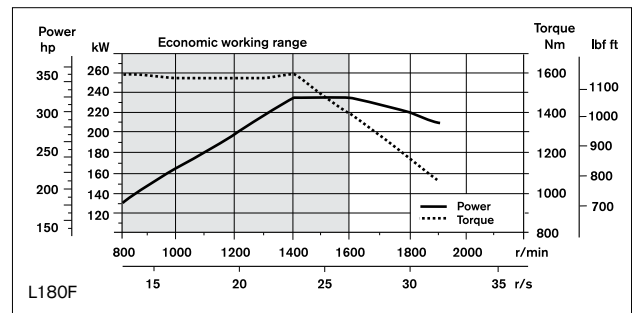

L220F

Engine	Volvo D12D LB E3
Max power at	26,7 r/s (1600 r/min)
SAE J1995 gross	261 kW (355 metric hp)
ISO 9249, SAE J1349 net	259 kW (352 metric hp)
Max torque at	23,3 r/s (1400 r/min)
SAE J1995 gross	1765 Nm
ISO 9249, SAE J1349 net	1756 Nm
Economic working range	800–1600 r/min
Displacement	12,13 l

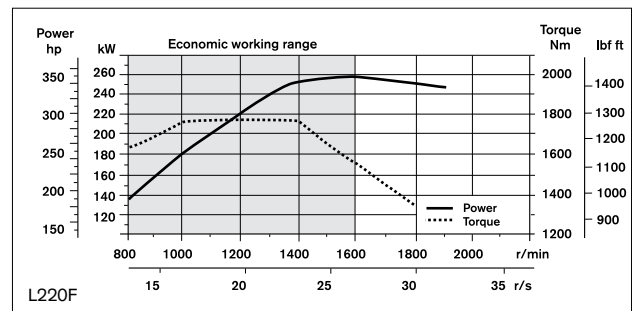



Drivetrain

Torque converter: Single-stage. **Transmission:** Volvo countershaft transmission with single lever control. Fast and smooth shifting of gears with Pulse Width Modulation (PWM) valve. **Gearshifting system:** Volvo Automatic Power Shift (APS) with fully automatic shifting 1-4 and mode selector with 4 different gearshifting programs, including AUTO mode. **Axles:** Volvo fully floating axle shafts with planetary hub reductions and cast steel axle housing. Fixed front axle and oscillating rear axle. 100% differential lock on the front axle. **Optional:** SmartShift converter with Lock up function on 2, 3 and 4 gear.

L150F

Transmission	Volvo HTE 210
Torque multiplication	2,4:1
Maximum speed, forward/reverse	
1st gear	6,5 km/h
2nd gear	12,5 km/h
3rd gear	25,1 km/h
4th gear	36,1 km/h
Measured with tires	26.5 R25 L3
Front axle/rear axle	Volvo/AWB 40B/40C
Rear axle oscillation	±15°
Ground clearance at 15° osc.	610 mm

L180F

Transmission	Volvo HTE 220
Torque multiplication	2,1:1
Maximum speed, forward/reverse	
1st gear	6,5 km/h
2nd gear	12,5 km/h
3rd gear	25,1 km/h
4th gear (limited by ECU)	36,1 km/h
Measured with tires	26.5 R25 L3
Front axle/rear axle	Volvo/AWB 40B/40B
Rear axle oscillation	±15°
Ground clearance at 15° osc.	610 mm

L220F

Transmission	Volvo HTE 305
Torque multiplication	2,05:1
Maximum speed, forward/reverse	
1st gear	7,0 km/h
2nd gear	12,5 km/h
3rd gear	25,0 km/h
4th gear (limited by ECU)	36,0 km/h
Measured with tires	29.5 R25 L3
Front axle/rear axle	Volvo/AWB 50/41
Rear axle oscillation	±15°
Ground clearance at 15° osc.	600 mm

* local restrictions may apply

Electrical system

Central warning system: Contronic electrical system with central warning light and buzzer for following functions: - Serious engine fault - Low steering system pressure - Overspeed warning engine - Interruption in communication (computer failure) Central warning light and buzzer with the gear engaged for the following functions. - Low engine oil pressure - High engine oil temperature - High charge-air temperature - Low coolant level - High coolant temperature - High crankcase pressure - Low transmission oil pressure - High transmission oil temperature - Low brake pressure - Engaged parking brake - Brake charging failure - Low hydraulic oil level - High hydraulic oil temperature - Overspeeding in engaged gear - High brake cooling oil temperature front and rear axles.

L150F, L180F, L220F

Voltage	24 V
Batteries	2x12 V
Battery capacity	2x140 Ah
Cold cranking capacity, approx	1050 A
Reserve capacity, approx	285 min
Alternator rating	2280 W/80 A
Starter motor output	7,0 kW (9,5 hp)

Brake system

Service brake: Volvo dual-circuit system with nitrogen-charged accumulators. Outboard-mounted hydraulically operated, fully sealed oil circulation-cooled wet disc brakes. The operator can select automatic disengagement of the transmission when braking using Contronic. **Parking brake:** Fully sealed, wet multi-disc brake built into the transmission. Applied by spring force and electro-hydraulically released with a switch on the instrument panel. **Secondary brake:** Dual brake circuits with rechargeable accumulators. Either one circuit or the parking brake fulfills all safety requirements. **Standard:** The brake system complies with the requirements of ISO 3450.

L150F, L180F

Number of brake discs per wheel front/rear	1/1
Accumulators	2x1,0 l and 1x0,5 l
Accumulators for parking brake	1x0,5 l

L220F

Number of brake discs per wheel front/rear	2/1
Accumulators	2x1,0 l, 1x0,5 l
Accumulators for parking brake	1x0,5 l

VOLVO L150F, L180F, L220F IN DETAIL



Cab

Instrumentation: All important information is centrally located in the operator's field of vision. Display for Contronic monitoring system. **Heater and defroster:** Heater coil with filtered fresh air and fan with auto and 11 speeds. Defroster vents for all window areas. **Operator's seat:** Operator's seat with adjustable suspension and retractable seatbelt. The seat is mounted on a bracket on the rear cab wall and floor. The forces from the retractable seatbelt are absorbed by the seat rails. **Standard:** The cab is tested and approved according to ROPS (ISO 3471, SAE J1040), FOPS (ISO 3449). The cab meets with requirements according to ISO 6055 (Operator overhead protection - Industrial trucks) and SAE J386 ("Operator Restraint System").

L150F

Emergency exit:	Use emergency hammer to break window
Sound level in cab according to ISO 6396	LpA 69 dB (A)
External sound level according to ISO 6395	LwA 107 dB (A)
Ventilation	9 m ³ /min
Heating capacity	15 kW
Air conditioning (optional)	8 kW

L180F

Emergency exit:	Use emergency hammer to break window
Sound level in cab according to ISO 6396	LpA 70 dB (A)
External sound level according to ISO 6395	LwA 108 dB (A)
Ventilation	9 m ³ /min
Heating capacity	15 kW
Air conditioning (optional)	8 kW

L220F

Emergency exit:	Use emergency hammer to break window
Sound level in cab according to ISO 6396	LpA 72 dB (A)
External sound level according to ISO 6395	LwA 108 dB (A)
Ventilation	9 m ³ /min
Heating capacity	15 kW
Air conditioning (optional)	8 kW

Lift arm system

Torque Parallel linkage (TP-linkage) with high breakout torque and parallel action throughout the entire lifting range.

L150F

Lift cylinders	2
Cylinder bore	160 mm
Piston rod diameter	90 mm
Stroke	784 mm
Tilt cylinder	1
Cylinder bore	230 mm
Piston rod diameter	110 mm
Stroke	452 mm

L180F

Lift cylinders	2
Cylinder bore	180 mm
Piston rod diameter	90 mm
Stroke	788 mm
Tilt cylinder	1
Cylinder bore	250 mm
Piston rod diameter	120 mm
Stroke	480 mm

L220F

Lift cylinders	2
Cylinder bore	190 mm
Piston rod diameter	90 mm
Stroke	768 mm
Tilt cylinder	1
Cylinder bore	260 mm
Piston rod diameter	120 mm
Stroke	455 mm



Hydraulic system

System supply: Three load-sensing axial piston pumps with variable displacement. The steering function always has priority. **Valves:** Double-acting 2-spool valve. The main valve is controlled by a 2-spool pilot valve. **Lift function:** The valve has four positions; lift, hold, lower, and float position. Inductive/magnetic automatic boom kick-out can be switched on and off and is adjustable to any position between maximum reach and full lifting height. **Tilt function:** The valve has three functions: rollback, hold and dump. Inductive/magnetic automatic tilt can be adjusted to the desired bucket angle. **Cylinders:** Double-acting cylinders for all functions. **Filter:** Full-flow filtration through 20 micron (absolute) filter cartridge.

L150F

Working pressure maximum, pump 1	24,0 MPa
Flow at engine speed	171 l/min 10 MPa 32 r/s (1900 r/min)
Working pressure maximum, pump 2	26,0 MPa
Flow at engine speed	180 l/min 10 MPa 32 r/s (1900 r/min)
Working pressure maximum, pump 3	21,0 MPa
Flow at engine speed	83 l/min 10 MPa 32 r/s (1900 r/min)
Pilot system, working pressure	3,5 MPa
Cycle times	
Lift*	5,9 s
Tilt*	2,0 s
Lower, empty	3,7 s
Total cycle time	11,6 s

L180F

Working pressure maximum, pump 1	24,0 MPa
Flow at engine speed	247 l/min 10 MPa 32 r/s (1900 r/min)
Working pressure maximum, pump 2	26,0 MPa
Flow at engine speed	180 l/min 10 MPa 32 r/s (1900 r/min)
Working pressure maximum, pump 3	21,0 MPa
Flow at engine speed	83 l/min 10 MPa 32 r/s (1900 r/min)
Pilot system, working pressure	3,5 MPa
Cycle times	
Lift*	6,4 s
Tilt*	1,8 s
Lower, empty	3,3 s
Total cycle time	11,5 s

L220F

Working pressure maximum, pump 1	24,0 MPa
Flow at engine speed	199 l/min 10 MPa 32 r/s (1900 r/min)
Working pressure maximum, pump 2	26,0 MPa
Flow at engine speed	234 l/min 10 MPa 32 r/s (1900 r/min)
Working pressure maximum, pump 3	21,0 MPa
Flow at engine speed	83 l/min 10 MPa 32 r/s (1900 r/min)
Pilot system, working pressure	3,5 MPa
Cycle times	
Lift*	5,8 s
Tilt*	1,6 s
Lower, empty	3,2 s
Total cycle time	10,6 s

* with load as per ISO 14397 and SAE J818

Steering system

Steering system: Load-sensing hydrostatic articulated steering. **System supply:** The steering system has priority feed from a load-sensing axial piston pump with variable displacement. **Steering cylinders:** Two double-acting cylinders.

L150F

Steering cylinders	2
Cylinder bore	90 mm
Rod diameter	50 mm
Stroke	423 mm
Working pressure	21 MPa
Maximum flow	190 l/min
Maximum articulation	±37°

L180F

Steering cylinders	2
Cylinder bore	100 mm
Rod diameter	50 mm
Stroke	418 mm
Working pressure	21 MPa
Maximum flow	190 l/min
Maximum articulation	±37°

L220F

Steering cylinders	2
Cylinder bore	100 mm
Rod diameter	60 mm
Stroke	502 mm
Working pressure	21 MPa
Maximum flow	234 l/min
Maximum articulation	±37°

VOLVO L150F, L180F, L220F IN DETAIL



Service

Service accessibility: Large, easy-to-open service doors with gas struts. Swing-out radiator grill. Fluid filters and component breather filters promote long service intervals. Possibility to log and analyze data to facilitate troubleshooting.

L150F refill capacities

Fuel tank	335 l
Engine coolant	45 l
Hydraulic oil tank	156 l
Transmission oil	45 l
Engine oil	42 l
Axle oil front/rear	45/55 l

L180F refill capacities

Fuel tank	335 l
Engine coolant	45 l
Hydraulic oil tank	156 l
Transmission oil	45 l
Engine oil	42 l
Axle oil front/rear	45/55 l

L220F refill capacities

Fuel tank	335 l
Engine coolant	45 l
Hydraulic oil tank	226 l
Transmission oil	45 l
Engine oil	42 l
Axle oil front/rear	77/71 l





SPECIFICATIONS

Tires L150F, L180F: 26.5 R25 L3. Tires L220F: 29.5 R25 L4

	Standard boom			Long boom		
	L150F	L180F	L220F	L150F	L180F	L220F
B	7070 mm	7170 mm	7470 mm	7570 mm	7600 mm	7790 mm
C	3550 mm	3550 mm	3700 mm	-	-	-
D	480 mm	480 mm	540 mm	-	-	-
F	3580 mm	3580 mm	3730 mm	-	-	-
G	2130 mm	2130 mm	2130 mm	-	-	-
J	3950 mm	4070 mm	4260 mm	4500 mm	4560 mm	4620 mm
K	4340 mm	4470 mm	4670 mm	4970 mm	4970 mm	5030 mm
O	58 °	57 °	56 °	-	-	-
P _{max}	50 °	49 °	49 °	-	-	-
R	44 °	44 °	43 °	47 °	48 °	44 °
R ₁ *	48 °	48 °	47 °	53 °	53 °	49 °
S	66 °	71 °	65 °	61 °	63 °	63 °
T	82 mm	123 mm	90 mm	136 mm	206 mm	100 mm
U	530 mm	570 mm	590 mm	640 mm	670 mm	670 mm
X	2280 mm	2280 mm	2400 mm	-	-	-
Y	2950 mm	2950 mm	3170 mm	-	-	-
Z	3510 mm	3810 mm	4060 mm	3970 mm	4170 mm	4390 mm
a ₂	6780 mm	6780 mm	7110 mm	-	-	-
a ₃	3830 mm	3830 mm	3940 mm	-	-	-
a ₄	±37 °	±37 °	±37 °	-	-	-

* Carry position SAE

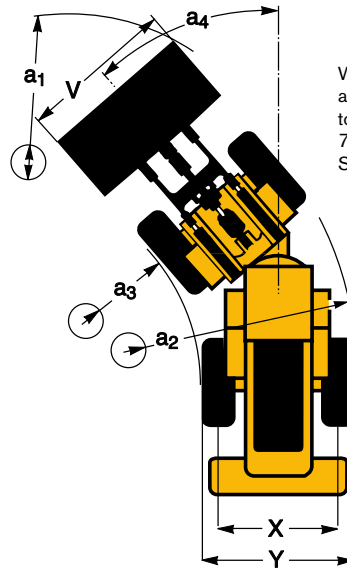

Where applicable, specifications and dimensions are according to ISO 7131, SAE J732, ISO 7546, SAE J742, ISO 14397, SAE J818.

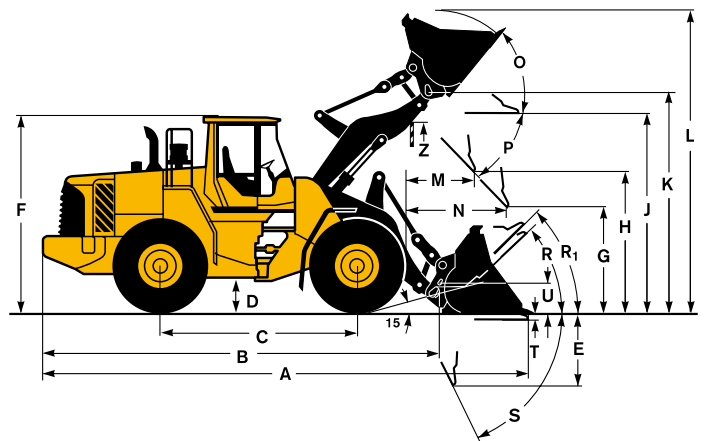







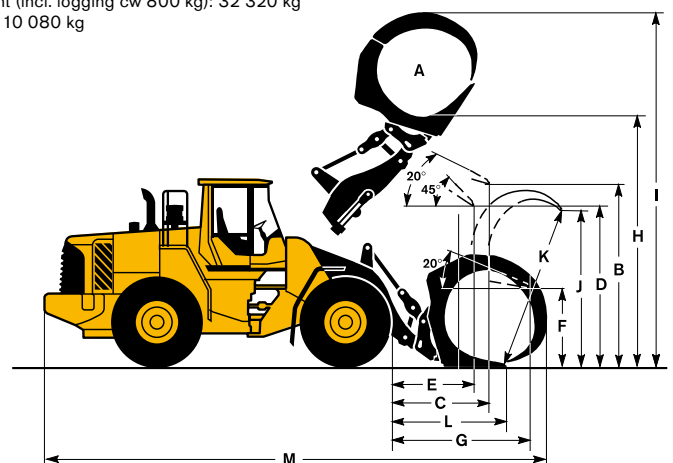

Tires L150F, L180F: 775/65 R29 L3
Tires L220F: 875/65 R29 L4

	L150F	L180F	L220F
A	3,1 m ²	3,5 m ²	4,0 m ²
B	3660 mm	3860 mm	3900 mm
C	2120 mm	1880 mm	2280 mm
D	2960 mm	3260 mm	3140 mm
E	1660 mm	1470 mm	1780 mm
F	1630 mm	1700 mm	1620 mm
G	2940 mm	2770 mm	3230 mm
H	5020 mm	5200 mm	5360 mm
I	7250 mm	7650 mm	7910 mm
J	3080 mm	3370 mm	3620 mm
K	3340 mm	3860 mm	3940 mm
L	2300 mm	2140 mm	2650 mm
M	9960 mm	10 240 mm	10 680 mm

- L150F** Sales code: WLA80927
Operating weight (incl. logging cw 1140 kg): 25 230 kg
Operating load: 7700 kg
- L180F** Sales code: WLA80693
Operating weight (incl. logging cw 1140 kg): 28 450 kg
Operating load: 8710 kg
- L220F** Sales code: WLA80851
Operating weight (incl. logging cw 800 kg): 32 320 kg
Operating load: 10 080 kg



L150F

Tires 26.5 R25 L3	GENERAL PURPOSE					REHAND-LING*	ROCK**		LIGHT MATERIAL	LONG BOOM	
											
Volume, heaped ISO/SAE	m ³	3,7	4,0	4,0	4,2	4,4	4,8	3,5	3,8	6,8	-
Volume at 110% fill factor	m ³	4,1	4,4	4,4	4,4	4,8	5,3	3,9	4,2	7,5	-
Static tipping load, straight	kg	16 780	17 380	17 380	17 240	17 010	16 970	18 090	17 760	16 470	-3360
at 35° turn	kg	14 930	15 500	15 490	15 360	15 120	15 070	16 100	15 810	14 620	-3070
at full turn	kg	14 720	15 280	15 280	15 150	14 910	14 850	15 870	15 580	14 410	-3040
Breakout force	kN	179,1	184,7	184,8	174,8	176,2	167,7	172,6	188,6	134,4	+9
A	mm	8620	8590	8790	8880	8670	8740	8890	8780	9140	+520
E	mm	1260	1230	1400	1480	1290	1350	1480	1380	1710	+19
H**)	mm	3010	3030	2900	2830	2970	2930	2840	2910	2620	+570
L	mm	5830	5880	5880	5960	5990	5890	5980	5940	6090	+570
M**)	mm	1250	1210	1360	1420	1260	1310	1410	1310	1560	-15
N**)	mm	1820	1800	1880	1910	1830	1850	1910	1840	1940	+440
V	mm	3200	3200	3230	3000	3200	3200	3230	3230	3200	-
a, clearance circle	mm	14 650	14 640	14 750	14 580	14 670	14 700	14 800	14 740	14 890	-
Operating weight	kg	23 560	23 320	23 330	23 370	23 660	23 720	24 810	24 790	23 820	+300





*) With L4 tires **) With L5 tires

**) Measured to the tip of the bucket teeth or bolt-on edge. Dump height to bucket edge. Measured at 45° dump angle. (Spade nose buckets at 42°)

Note: This only applies to genuine Volvo attachments.

Bucket Selection Chart

The chosen bucket is determined by the density of the material and the expected bucket fill factor. The actual bucket volume is often larger than the rated capacity, due to the features of the TP linkage, including an open bucket design, good rollback angles in all positions and good bucket filling performance. The example represents a standard boom configuration. **Example: Sand and gravel. Fill factor ~ 105%. Density 1,6 t/m³. Result: The 4,0 m³ bucket carries 4,2 m³. For optimum stability always consult the bucket selection chart.**

Material	Bucket fill, %		Material density, t/m ³	ISO/SAE bucket volume, m ³	Actual volume, m ³
Earth/Clay	~ 110		~ 1,6	3,8	~ 4,2
			~ 1,6	4,0	~ 4,4
			~ 1,5	4,2	~ 4,6
Sand/Gravel	~ 105		~ 1,7	3,8	~ 4,0
			~ 1,6	4,0	~ 4,2
			~ 1,6	4,2	~ 4,4
Aggregate	~ 100		~ 1,8	3,8	~ 3,8
			~ 1,7	4,0	~ 4,0
			~ 1,6	4,2	~ 4,2
Rock	≤100		~ 1,7	3,5	~ 3,5

The size of rock buckets is optimized for optimal penetration and filling capability rather than the density of the material.

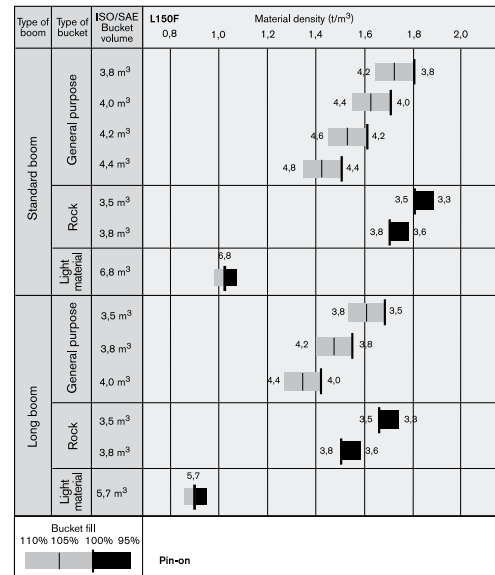









How to read bucket fill factor

Supplemental Operating Data

Tires 26.5 R25 L3		Standard boom		Loong boom	
		26.5 R25 L5	775/65 R29 L3	26.5 R25 L5	775/65 R29 L3
Width over tires	mm	+30	+180	+30	+180
Ground clearance	mm	+30	+10	+30	+10
Tipping load, full turn	kg	+760	+590	+640	+500
Operating weight	kg	+1060	+760	+1050	+750

L180F

Tires 26.5 R25 L3	GENERAL PURPOSE					REHAND-LING*	ROCK**		LIGHT MATERIAL	LONG BOOM	
											
Volume, heaped ISO/SAE	m ³	4,4	4,4	4,6	4,6	4,8	5,2	4,4	4,2	7,8	-
Volume at 110% fill factor	m ³	4,8	4,8	5,1	5,1	5,3	5,7	4,8	4,6	8,6	-
Static tipping load, straight	kg	20 130	20 790	20 900	20 810	20 700	20 680	21 280	21 510	19 750	-3660
at 35° turn	kg	17 820	18 430	18 530	18 440	18 340	18 290	18 860	19 050	17 440	-3330
at full turn	kg	17 550	18 160	18 260	18 170	18 080	18 020	18 590	18 770	17 170	-3290
Breakout force	kN	202,5	215,3	214,7	215,3	206,0	204,2	215,6	194,3	157,9	+4,0
A	mm	8880	9030	8790	9030	8860	8880	9000	9160	9340	+470
E	mm	1440	1570	1360	1570	1420	1440	1530	1680	1860	+37
H**)	mm	3060	2950	3110	2950	3060	3050	2980	2870	2690	+490
L	mm	6170	6120	6170	6170	6170	6000	6210	6310	6300	+490
M**)	mm	1360	1430	1280	1430	1330	1330	1390	1520	1620	+20
N**)	mm	1970	2010	1930	2010	1960	1950	1980	2060	2050	+400
V	mm	3200	3230	3200	3230	3200	3400	3230	3230	3400	-
a ₁ clearance circle	mm	14 800	14 900	14 760	14 900	14 790	14 990	14 890	14 970	15 220	-
Operating weight	kg	26 810	26 560	26 540	26 600	26 600	26 680	27 910	28 000	26 970	+280





*) With L4 tires **) With L5 tires

**) Measured to the tip of the bucket teeth or bolt-on edge. Dump height to bucket edge. Measured at 45° dump angle. (Spade nose buckets at 42°)

Note: This only applies to genuine Volvo attachments.

Bucket Selection Chart

The chosen bucket is determined by the density of the material and the expected bucket fill factor. The actual bucket volume is often larger than the rated capacity, due to the features of the TP linkage, including an open bucket design, good rollback angles in all positions and good bucket filling performance. The example represents a standard boom configuration. **Example: Sand and gravel. Fill factor ~ 105%. Density 1,6 t/m³. Result: The 4,6 m³ bucket carries 4,8 m³. For optimum stability always consult the bucket selection chart.**

Material	Bucket fill, %		Material density, t/m ³	ISO/SAE bucket volume, m ³	Actual volume, m ³
Earth/Clay	~ 110		~ 1,6	4,4	~ 4,8
			~ 1,5	4,6	~ 5,1
			~ 1,4	4,8	~ 5,3
Sand/Gravel	~ 105		~ 1,7	4,4	~ 4,6
			~ 1,6	4,6	~ 4,8
			~ 1,5	4,8	~ 5,1
Aggregate	~ 100		~ 1,8	4,4	~ 4,4
			~ 1,7	4,6	~ 4,6
			~ 1,6	4,8	~ 4,8
Rock	≤100		~ 1,7	4,3	~ 4,3

The size of rock buckets is optimized for optimal penetration and filling capability rather than the density of the material.

Supplemental Operating Data

		Standard boom		Loong boom	
		Tires 26.5 R25 L3	26.5 R25 L5	775/65 R29 L3	26.5 R25 L5
Width over tires	mm	+30	+130	+30	+130
Ground clearance	mm	+40	+10	+40	+10
Tipping load, full turn	kg	+770	+600	+760	+530
Operating weight	kg	+1050	+920	+1050	+1120

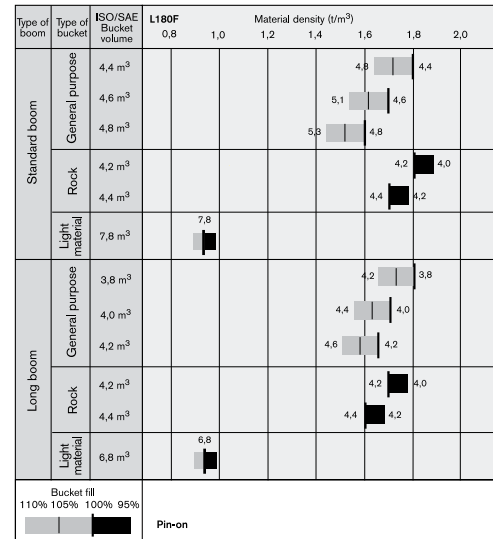

Tires 29.5 R25 L4	GENERAL PURPOSE				REHAND-LING*	ROCK**			LIGHT MATERIAL	LONG BOOM	
	Bolt-on edges	Teeth	Bolt-on edges	Teeth	Bolt-on edges	Teeth	Teeth	Teeth	Bolt-on edges		
Volume, heaped ISO/SAE	m ³	4,9	5,2	5,4	5,6	5,6	4,5	4,5	5,0	8,2	-
Volume at 110% fill factor	m ³	5,4	5,7	5,9	6,2	6,2	5,0	5,0	5,5	9,0	-
Static tipping load, straight	kg	23 770	23 580	23 680	23 450	23 360	23 840	23 390	22 570	22 530	-2860
at 35° turn	kg	21 140	20 960	21 050	20 810	20 730	21 180	20 750	19 990	19 950	-2630
at full turn	kg	20 840	20 660	20 750	20 520	20 430	20 880	20 450	19 700	19 660	-2650
Breakout force	kN	231,0	224,7	224,5	220,2	207,0	240,9	192,7	178,7	172,6	+3,0
A	mm	9050	9330	9090	9360	9240	9220	9590	9740	9550	+310
E	mm	1280	1520	1320	1560	1450	1440	1760	1890	1730	-20
H**)	mm	3310	3130	3280	3100	3190	3190	3000	2900	2940	+360
L	mm	6390	6450	6500	6540	6290	6450	6390	6480	6480	+360
M**)	mm	1260	1450	1290	1470	1380	1370	1710	1810	1580	-30
N**)	mm	2020	2140	2040	2150	2090	2080	2250	2290	2170	+270
V	mm	3400	3400	3400	3400	3400	3430	3430	3430	3700	-
a ₁ clearance circle	mm	15 470	15 610	15 500	15 630	15 560	15 580	15 770	15 850	16 010	-
Operating weight	kg	31 190	31 300	31 330	31 520	31 260	31 830	32 000	32 170	31 760	+380





*) With L4 tires **) With L5 tires

**) Measured to the tip of the bucket teeth or bolt-on edge. Dump height to bucket edge. Measured at 45° dump angle. (Spade nose buckets at 42°)

Note: This only applies to genuine Volvo attachments.

Bucket Selection Chart

The chosen bucket is determined by the density of the material and the expected bucket fill factor. The actual bucket volume is often larger than the rated capacity, due to the features of the TP linkage, including an open bucket design, good rollback angles in all positions and good bucket filling performance. The example represents a standard boom configuration. **Example: Sand and gravel. Fill factor ~ 105%. Density 1,6 t/m³. Result: The 5,2 m³ bucket carries 5,5 m³. For optimum stability always consult the bucket selection chart.**

Material	Bucket fill, %		Material density, t/m ³	ISO/SAE bucket volume, m ³	Actual volume, m ³
Earth/Clay	~ 110		~ 1,6	4,9	~ 5,4
			~ 1,5	5,2	~ 5,7
			~ 1,4	5,4	~ 5,9
Sand/Gravel	~ 105		~ 1,7	4,9	~ 5,1
			~ 1,6	5,2	~ 5,5
			~ 1,5	5,4	~ 5,7
Aggregate	~ 100		~ 1,8	4,9	~ 4,9
			~ 1,7	5,2	~ 5,2
			~ 1,6	5,4	~ 5,4
Rock	≤100		~ 1,7	4,5	~ 4,5

The size of rock buckets is optimized for optimal penetration and filling capability rather than the density of the material.

Supplemental Operating Data

Tires 29.5 R25 L4	Standard boom			Loong boom			
	29.5 R25 L3	29.5 R25 L5	875/65 R29 L4	29.5 R25 L3	29.5 R25 L5	875/65 R29 L4	
Width over tires	mm	-20	+35	+95	-20	+35	+95
Ground clearance	mm	±0	+40	-10	±0	+40	-20
Tipping load, full turn	kg	-100	+1010	+180	-90	+930	+180
Operating weight	kg	-80	+1490	+650	-80	+1500	+650

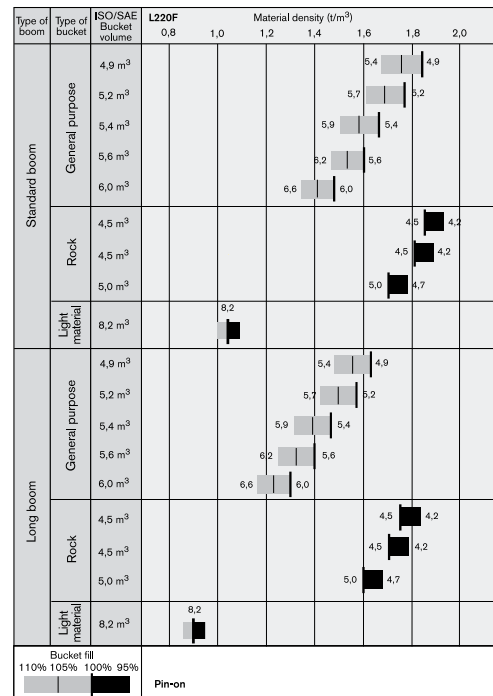

STANDARD EQUIPMENT

Service and maintenance

	L150F	L180F	L220F
Engine oil remote drain and fill	•	•	•
Transmission oil remote drain and fill	•	•	•
Lubrication manifolds, ground accessible	•	•	•
Pressure check connections: transmission and hydraulic, quick-connects	•	•	•
Tool box, lockable	•	•	•

Engine

	L150F	L180F	L220F
Three stage air cleaner, pre-cleaner, primary and secondary filter	•	•	•
Indicator glass for coolant level	•	•	•
Preheating of induction air	•	•	•
Fuel pre-filter with water trap	•	•	•
Fuel filter	•	•	•
Crankcase breather oil trap	•	•	•
Exhaust heat insulation	•	•	•

Electrical system

	L150F	L180F	L220F
24 V, pre-wired for optional accessories	•	•	•
Alternator 24V/ 80A	•	•	•
Battery disconnect switch with removable key	•	•	•
Fuel gauge	•	•	•
Hour meter	•	•	•
Electric horn	•	•	•
Instrument cluster: <ul style="list-style-type: none"> • Fuel level • Transmission temperature • Coolant temperature • Instrument lighting 	•	•	•
Lighting: <ul style="list-style-type: none"> • Twin halogen front headlights with high and low beams • Parking lights • Double brake and tail lights • Turn signals with flashing hazard light function • Halogen work lights (2 front and 2 rear) 	•	•	•

Contronic monitoring system

	L150F	L180F	L220F
Monitoring and logging of machine data	•	•	•
Contronic display	•	•	•
Fuel consumption	•	•	•
Ambient temperature	•	•	•
Clock	•	•	•
Test function for warning and indicator lights	•	•	•
Brake test	•	•	•
Test function, sound level at max fan speed	•	•	•
Warning and indicator lights: <ul style="list-style-type: none"> • Battery charging • Parking brake 	•	•	•
Warning and display message: <ul style="list-style-type: none"> • Engine coolant temperature • Charge-air temperature • Engine oil temperature • Engine oil pressure • Transmission oil temperature • Transmission oil pressure • Hydraulic oil temperature • Brake pressure • Parking brake applied • Brake charging • Overspeed at direction change • Axle oil temperature • Steering pressure • Crankcase pressure • Attachment lock open 	•	•	•
Level warnings: <ul style="list-style-type: none"> • Fuel level • Engine oil level • Engine coolant level • Transmission oil level • Hydraulic oil level • Washer fluid level 	•	•	•
Engine torque reduction in case of malfunction indication: <ul style="list-style-type: none"> • High engine coolant temperature • High engine oil temperature • Low engine oil pressure • High crankcase pressure • High charge-air temperature 	•	•	•
Engine shutdown to idle in case of malfunction indication: <ul style="list-style-type: none"> • High transmission oil temperature • Slip in transmission clutches 	•	•	•

L150F L180F L220F

	L150F	L180F	L220F
Keypad, background lit	•	•	•
Start interlock when gear is engaged	•	•	•

Drivetrain

	L150F	L180F	L220F
Automatic Power Shift	•	•	•
Fully automatic gearshifting, 1-4	•	•	•
PWM-controlled gearshifting	•	•	•
Forward and reverse switch by hydraulic lever console	•	•	•
Indicator glass for transmission oil level	•	•	•
Differentials: Front, 100% hydraulic diff lock. Rear, conventional.	•	•	•

Brake system

	L150F	L180F	L220F
Dual brake circuits	•	•	•
Dual brake pedals	•	•	•
Secondary brake system	•	•	•
Parking brake, electrical-hydraulic	•	•	•
Brake wear indicators	•	•	•

Cab

	L150F	L180F	L220F
ROPS (ISO 3471), FOPS (ISO 3449)	•	•	•
Single key kit door/start	•	•	•
Acoustic inner lining	•	•	•
Ashtray	•	•	•
Cigarette lighter, 24 V power outlet	•	•	•
Lockable door	•	•	•
Cab heating with fresh air inlet and defroster	•	•	•
Fresh air inlet with two filters	•	•	•
Automatic heat control	•	•	•
Floor mat	•	•	•
Dual interior lights	•	•	•
Dual interior rear-view mirrors	•	•	•
Dual exterior rear-view mirrors	•	•	•
Sliding window, right side	•	•	•
Tinted safety glass	•	•	•
Retractable seatbelt (SAE J386)	•	•	•
Adjustable steering wheel	•	•	•
Storage compartment	•	•	•
Document pocket	•	•	•
Sun visor	•	•	•
Beverage holder	•	•	•
Windshield washer front and rear	•	•	•
Windshield wipers front and rear	•	•	•
Interval function for front and rear wipers	•	•	•

Hydraulic system

	L150F	L180F	L220F
Main valve, double acting 2-spool with hydraulic pilots	•	•	•
Variable displacement axial piston pumps (3) for: <ul style="list-style-type: none"> 1 Working hydraulic system 2 Working hydraulic system, Pilot hydraulic, Steering- and Brake system 3 Cooling fan and Brake system 	•	•	•
Hydraulic control levers	•	•	•
Electric level lock	•	•	•
Boom kick-out, automatic	•	•	•
Bucket positioner, automatic	•	•	•
Double-acting hydraulic cylinders	•	•	•
Indicator glass for hydraulic oil level	•	•	•
Hydraulic oil cooler	•	•	•

External equipment

	L150F	L180F	L220F
Fenders, front and rear	•	•	•
Viscous cab mounts	•	•	•
Rubber engine and transmission mounts	•	•	•
Easy-to-open side panels	•	•	•
Frame, joint lock	•	•	•
Vandalism lock prepared for <ul style="list-style-type: none"> • Batteries • Engine compartment • Radiator grille 	•	•	•
Lifting eyes	•	•	•
Tie-down eyes	•	•	•
Tow hitch	•	•	•

OPTIONAL EQUIPMENT (Standard on certain markets)

Service and maintenance

	L150F	L180F	L220F
Automatic lubrication system	•	•	•
Automatic lubrication system for long boom	•	•	•
Automatic lubrication system, stainless steel	•	•	•
Automatic lubrication system, stainless steel for Long boom	•	•	•
Automatic lubrication system for attachment bracket, welded	•	•	•
Automatic lubrication system, stainless steel for attachment bracket, welded	•	•	•

L150F L180F L220F

	L150F	L180F	L220F
Grease nipple guards	•	•	•
Oil sampling valve	•	•	•
Refill pump for grease to lube system	•	•	•
Tool kit	•	•	•
Wheel nut wrench kit	•	•	•

Engine	L150F	L180F	L220F
Air pre-cleaner, cyclone type	•	•	•
Air pre-cleaner, cyclone type, two-stage	•	•	•
Air pre-cleaner, oil-bath type	•	•	•
Air pre-cleaner, turbo type	•	•	•
Cooling package: Radiator and charge air cooler, corrosion protection	•	•	•
Engine auto shutdown	•	•	•
Engine block heater, 230 V	•	•	•
ESW, Disabled engine protection	•	•	•
ESW, Increased engine protection	•	•	•
Exterior radiator air intake protection	•	•	•
Fan air intake protection, extra close-meshed	•	•	•
Fuel fill strainer	•	•	•
Fuel heater	•	•	•
Hand throttle control	•	•	•
Max. fan speed, hot climate	•	•	•
Radiator, corrosion-protected	•	•	•
Reversible cooling fan	•	•	•
Reversible cooling fan and axle oil cooler	•	•	•

Electrical system	L150F	L180F	L220F
Alternator, 80 A with air filter	•	•	•
Anti-theft device	•	•	•
Headlights, assym. left	•	•	•
License plate holder, lighting	•	•	•
Rear view camera incl. monitor, colour	•	•	•
Rear-view mirrors, adjustable, el.heated	•	•	•
Reduced function working lights, reverse gear activated	•	•	•
Reverse alarm	•	•	•
Shortened headlight support brackets	•	•	•
Side marker lamps	•	•	•
Rotating beacon	•	•	•
Working lights, attachments	•	•	•
Working lights front, high intensity discharge (HID)	•	•	•
Working lights front, on cab, dual	•	•	•
Working lights front, extra	•	•	•
Working lights rear, on cab	•	•	•
Working lights rear, on cab, dual	•	•	•

Cab	L150F	L180F	L220F
Anchorage for Operator's manual	•	•	•
Automatic Climate Control, ACC	•	•	•
ACC control panel, with Fahrenheit scale	•	•	•
Asbestos dust protection filter	•	•	•
Cab air pre-cleaner, cyclone type	•	•	•
Carbon filter	•	•	•
Cover plate, under cab	•	•	•
Lunch box holder	•	•	•
Armrest, operator's seat, ISRI, left only	•	•	•
Armrest, operator's seat, KAB, left only	•	•	•
Operator's seat, KAB, air susp, heavy-duty, not for CDC	•	•	•
Operator's seat, KAB, air susp, heavy-duty, for CDC and "elservo"	•	•	•
Operator's seat, ISRI, air susp, heat, high back	•	•	•
Operator's seat, ISRI, heated, high back	•	•	•
Operator's seat, ISRI, low back	•	•	•
Radio installation kit incl. 11 amp 12 volt outlet, left side	•	•	•
Radio installation kit incl. 11 amp 12 volt outlet, right side	•	•	•
Radio installation kit incl. 20 amp 12 volt outlet	•	•	•
Radio with CD-player	•	•	•
Seatbelt, 3", (width 75 mm)	•	•	•
Steering wheel knob	•	•	•
Sun blinds, rear windows	•	•	•
Sun blinds, side windows	•	•	•
Timer cab heating	•	•	•
Window, sliding, door	•	•	•
Universal door/ignition key	•	•	•

Drivetrain	L150F	L180F	L220F
Diff lock front 100%, Limited Slip rear	•	•	•
Diff.lock, limited slip front and rear in comb. with axle oil cooler	•	•	•
Speed limiter, 20 km/h	•	•	•
Speed limiter, 30 km/h	•	•	•
Speed limiter, 40 km/h	•	•	•
Wheel/axle seal guards	•	•	•
SmartShift	•	•	•

Brake system	L150F	L180F	L220F
Oil cooler and filter front & rear axle	•	•	•
Stainless steel, brake lines	•	•	•

Hydraulic system	L150F	L180F	L220F
Attachment bracket, welded	•	•	•
Boom suspension system	•	•	•
Separate attachment locking, standard boom	•	•	•

Separate attachment locking, long boom	•	•	•
Arctic kit, attachment locking hoses and 3rd hydr. function	•	•	•
Arctic kit, pilot hoses and brake accum. incl. hydr. oil	•	•	•
Boom cylinder hose and tube guards	•	•	•
Boom cylinder hose and tube guards for long boom	•	•	•
Hydraulic fluid, biodegradable, Volvo	•	•	•
Hydraulic fluid, fire-resistant	•	•	•
Hydraulic fluid, for hot climate	•	•	•
Hydraulic function, 3rd	•	•	•
Hydraulic function, 3rd for long boom	•	•	•
Hydraulic function, 3rd-4th	•	•	•
Electro-hydraulic function, 3rd	•	•	•
Electro-hydraulic function, 3rd for long boom	•	•	•
Electro-hydraulic function, 3rd-4th	•	•	•
Electro-hydraulic function, 3rd-4th for long boom	•	•	•
Electro-hydraulic servo controls	•	•	•
Electro-hydraulic servo controls for long boom	•	•	•
Single lever control	•	•	•
Single lever control for 3rd hydraulic function	•	•	•
Hydraulic oil cooler, extra	•	•	•

External equipment	L150F	L180F	L220F
Cab ladder, rubber-suspended	•	•	•
Deleted front mudguards	•	•	•
Flexible rear step	•	•	•
Mudguard widener, front/rear for 80-series tires	•	•	•
Mudguard widener, front/rear for 65-series tires	•	•	•
Mudguards, fixed front and swing out rear, mudguard wideners incl.	•	•	•
Long boom	•	•	•
Long boom for electro-hydraulic	•	•	•

Protective equipment	L150F	L180F	L220F
Belly guard front	•	•	•
Belly guard rear	•	•	•
Belly guard rear, oil pan	•	•	•
Cover plate, heavy-duty, front frame	•	•	•
Guards for front headlights	•	•	•
Guards for radiator grill	•	•	•
Guards for tail lights	•	•	•
Guards for tail lights, heavy-duty	•	•	•
Windows, side and rear guards	•	•	•
Windshield guard	•	•	•
Corrosion protection, painting of machine	•	•	•
Corrosion protection, painting of attachment bracket	•	•	•
Steer cylinder guards	•	•	•
Bucket Teeth protection	•	•	•

Other equipment	L150F	L180F	L220F
CE-marking	•	•	•
Comfort Drive Control (CDC)	•	•	•
Comfort drive control, (CDC), electro-hydraulic	•	•	•
Counterweight, logging	•	•	•
Counter weight, block handling	•	•	•
Counterweight, re-handling	•	•	•
Counterweight, signal painted, chevrons	•	•	•
Log pusher	•	•	•
Secondary steering with automatic test function	•	•	•
Sound decal, EU	•	•	•
Noise reduction kit, exterior	•	•	•
Sign, slow moving vehicle	•	•	•
CareTrack, GSM	•	•	•
CareTrack, GSM/Satellite	•	•	•

Tires	L150F	L180F	L220F
26.5 R25	•	•	•
29.5 R25	•	•	•
775/65 R29	•	•	•
875/65 R29	•	•	•

Attachments	L150F	L180F	L220F
Buckets:			
• Rock straight or spade nose	•	•	•
• General purpose	•	•	•
• Re-handling	•	•	•
• Side-dump	•	•	•
• Light material	•	•	•
Wear parts:			
• Bolt-on and weld-on bucket teeth	•	•	•
• Segments	•	•	•
• Cutting edge in three sections, bolt-on	•	•	•
Fork equipment	•	•	•
Material handling arm	•	•	•
Log grapples	•	•	•

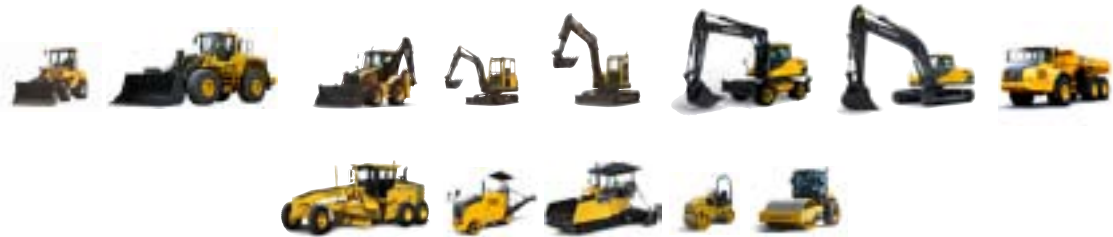

Volvo Construction Equipment is different. Our machines are designed, built and supported in a different way. That difference comes from an engineering heritage of over 175 years. A heritage of thinking first about the people who actually use the machines. About how to help them be safer, more comfortable, more productive. About the environment we all share. The result of that thinking is a growing range of machines and a global support network dedicated to helping you do more. People around the world are proud to use Volvo. And we're proud of what makes Volvo different – **More care. Built in.**



Not all products are available in all markets. Under our policy of continuous improvement, we reserve the right to change specifications and design without prior notice. The illustrations do not necessarily show the standard version of the machine.

VOLVO

Volvo Construction Equipment
www.volvoce.com

Ref. No. VOE21D1002739
Printed in Sweden 2009-10-0,0
Volvo, Eskilstuna

English
WLO